

PART NUMBER: CMS0361KLX

DESCRIPTION: speaker

SPECIFICATIONS

nominal size	36 x 36 x 14.5 mm		
impedance	8 Ohm \pm 15%	at	1 kHz 1 V
resonant frequency	230 Hz \pm 46 Hz	at	1 V
sound pressure level	82 dB/W \pm 3 dB	1 W 50 cm ave. at 0.3 k, 0.4 k, 0.5 k, 0.6 kHz	
response	Fo Hz ~ 20 kHz max 10 dB		
input power	nominal 2 W	handling capacity	4 W
operation	must be normal at program source 2 W		
buzz, rattle, etc.	must be normal at sine wave 4 V		
magnet	size: 18.7 x 4.0 mm		
load test	white noise 2 W	for	24 hours
heat test	65 \pm 2° C	20-50% R.H.	24 hours
humidity test	40 \pm 2° C	90-95% R.H.	24 hours

FREQUENCY RESPONSE CURVE

potentiometer range	50 dB
rectifier	RMS
lower limit frequency	20 Hz
wr. speed	100 mm/sec

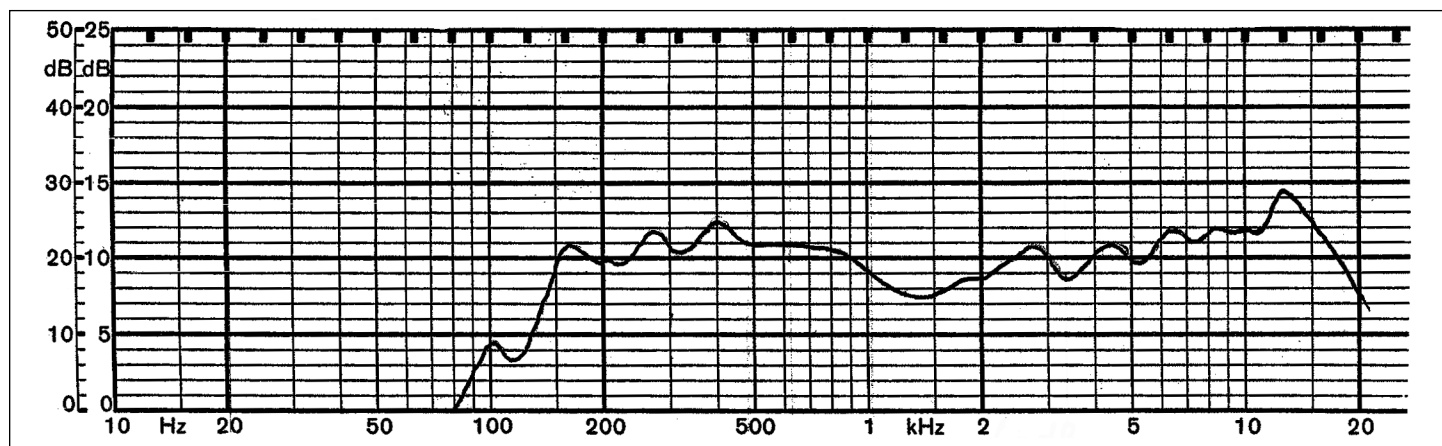

zero level 60 dB

REV.	DESCRIPTION	DATE
A	NEW DRAWING	10/2/2006

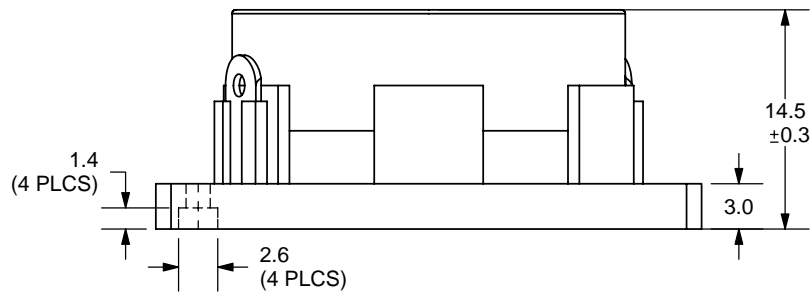
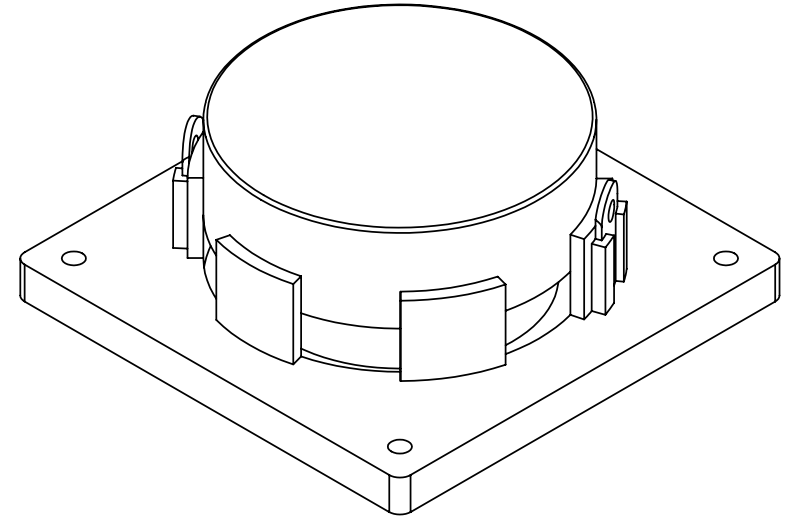
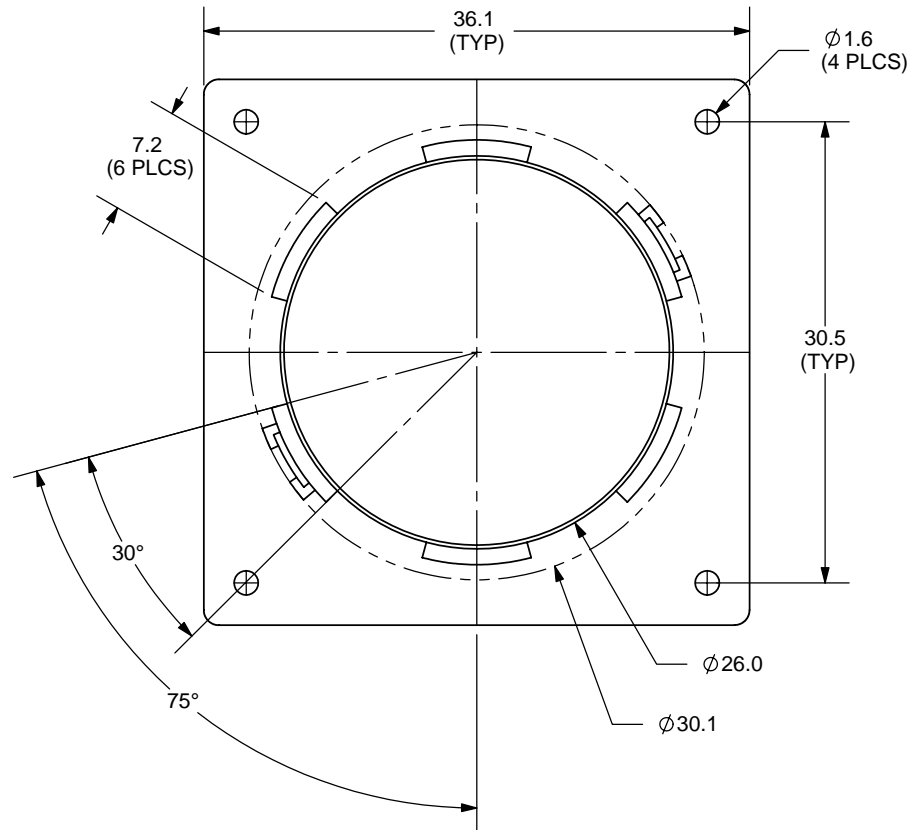

TOLERANCE:
±0.2mm UNLESS OTHERWISE
SPECIFIED



20050 SW 112th Ave.
Tualatin, OR 97062
Phone: 503-643-4899
800-275-4899
Fax: 503-372-1266
Website: www.cui.com

TITLE: MINIATURE MONITOR SPEAKER		REV: A
PART NO. CMS0361KLX	UNITS: MM [INCHES]	
DRAWN BY: ZRJ	APPROVED BY:	SCALE: 2:1

PC FILE NAME:
CMS0361KLX

COPYRIGHT 2006 BY CUI INC.